

uni**pro**[®]

Making your
lights shine

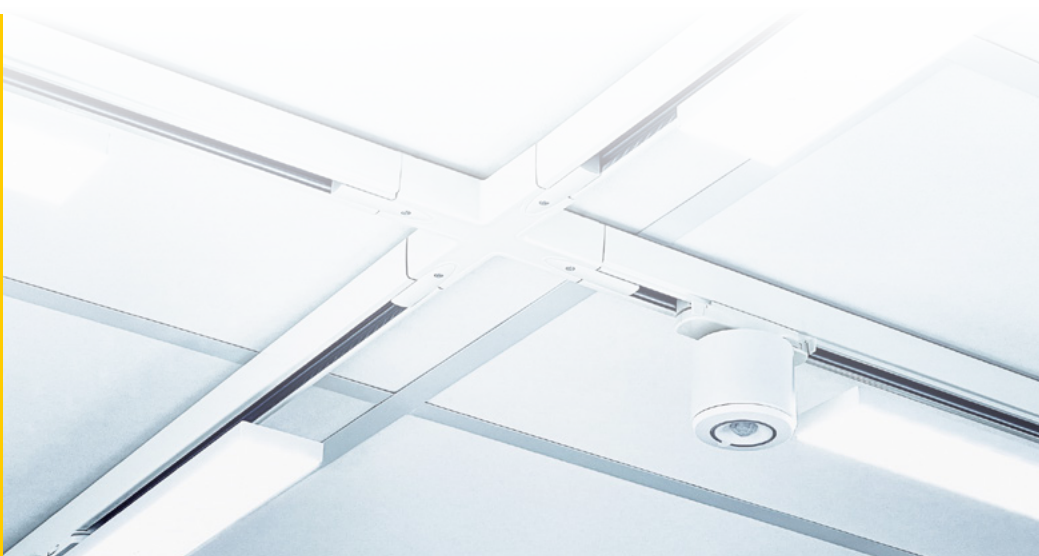

PRODUCT CATALOGUE



2024



Making your lights shine

Unipro Oy Ltd with its parent company Meka Pro Ltd are both part of the privately owned Propria Group in Finland. Unipro (www.unipro.fi) is specialized in manufacturing high quality lighting track products. Unipro products are already sold in over 50 countries. New and modern factory is located in Hämeenlinna, Finland, close to all the main routes and harbours.

The unipro® lighting track system is a great and popular choice for offices, shopping centers, shops, museums, gyms and restaurants - only your imagination is the limit. It is a flexible solution for situations where the customer needs to increase or decrease the lighting space or re-arrange the lighting in general.

Unipro is the word for high quality products, modern design and smooth installation. The unipro® lighting track system offers flexibility in designing advanced lighting systems.

Our system includes surface and recessed 3-phase and Control-DALI lighting tracks, adapters and a wide range of mounting accessories.

Universal and modular design is easy to expand and adapt to the customer's wishes and requirements.

L-corners are adjustable and reversible with changeable earthing for fast and easy installation.

In fire-safety situations halogen-free lighting track parts will not release any flammable gases harmful for health. It is advisable to use halogen free products especially in premises full of people and challenging evacuation conditions.



Unipro has completed the carbon footprint study –
Please get in touch if you want to know more about our
carbon footprint report.

Green aluminium

In today's world, everyone is concerned about the environment and therefore industries and businesses are seeking innovative solutions to reduce their carbon footprint. One such method is the adoption of green aluminum, that promises a more sustainable future.

Unipro® is now offering green aluminum to those customers, who are requesting low-carbon footprint products. This green aluminum substantially reduces the carbon footprint. One ton of 100% recycled aluminum saves approximately 6 tons of bauxite and 9 tons of CO2 carbon emissions.



PVC halogen free products

What are halogens and why should you care? Elements like fluorine, chlorine, bromine, iodine and astatine are found in many chemical compounds like in PVC (polyvinylchloride). As we are aware of, PVC is used in many technical products to make them more durable. PVC is also used for insulation while other halogens are added to improve flame protection. However, halogens are harmful to human health. Particularly, in a situation where halogenated plastics and particularly PVC, burn. In a case of fire these halogens react with water or fluids and create a dangerous hydrochloric acid, other mixtures of dioxins and toxic chemicals. These can seriously damage health or even cause some mortalities.

This is why all Unipro connectors, adapters and 3-phase DALI tracks are manufactured completely using PVC- and Halogen free plastics.

Plastic free packages

Humans are sinking the world with plastic. This is an enormous challenge for our environment. We need to act and that is why we at Unipro decided to remove as much plastic as possible from our packages. Today Unipro has reduced the use of plastic already by 1Tonne annually. This was achieved by re-designing the adapter-, connector- and track packages.



Smart partners

Most recently Unipro has partnered with Helvar to offer their intelligent solutions to the 3-phase DALI track system. The new Helvar ActiveAhead® is a truly intelligent and scalable wireless lighting solution. Its unique self-learning capabilities give ultimate efficiency in setup and operations. ActiveAhead® will continuously learn and generate insights, maximising positive impact on wellbeing and optimising your ever-evolving building. Helvar ActiveAhead® is the perfect solution for offices, warehouses, stairways and parking garages.

Universal solutions

The unipro® lighting tracks are designed for surface and recessed installations. All Unipro tracks are compatible with most common adapters. Flat or round copper conductors provide the best possible electrical contact and require minimum work before installation.

The unipro® 3-phase adapters A75 (5 kg) and A90 (10 kg) are compatible with most 3-phase lighting tracks. Also the A90C (10 kg) 3-phase DALI adapter is suitable with most compatible DALI tracks in the market. The A200 Driver adapter family offers the latest technology with the integrated drivers.

All connection units have reliable and easy-to-use screw terminals for 2.5mm² solid or braided wires. Power supply options are available on most of the connector pieces, such as MCU, L-corners, T-piece and X-unit.

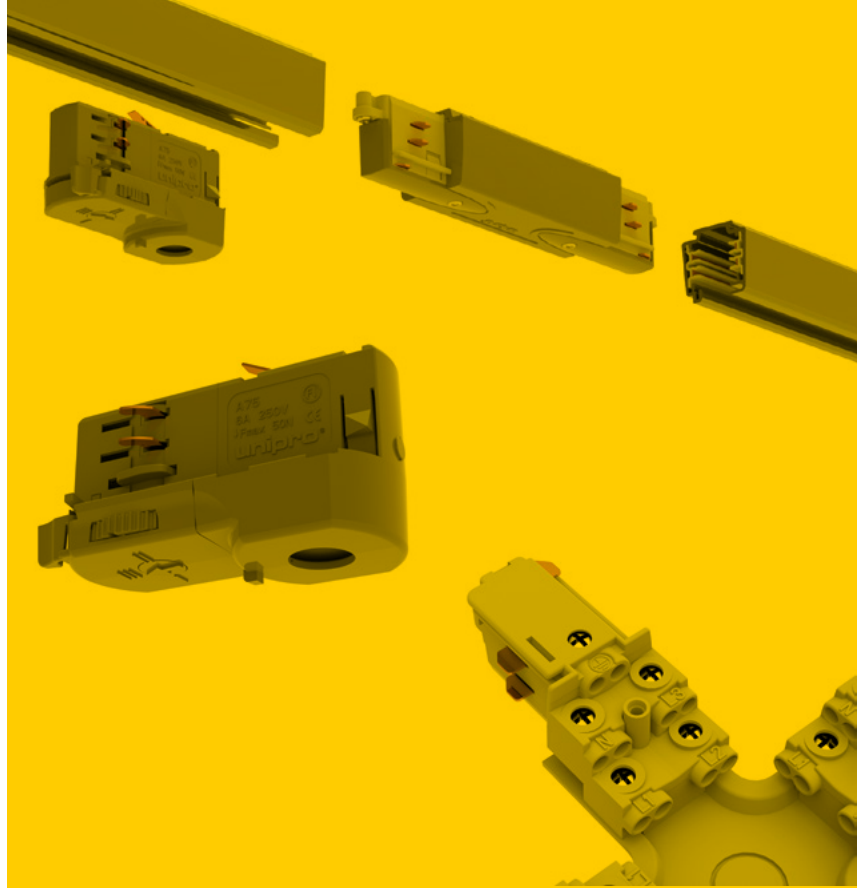

Wide selection of track lengths

Unipro offers a wide selection of track lengths suitable for various solutions. Lengths vary from 1,2 m to 4m and this allows the designers and architects to maximize the different possibilities in their design. We can also provide special requests as made-to-measure lengths accordingly.

Easy to install

The suspension parts for Unipro tracks can be used for all track products. They are easy to use and can be installed even without any special tools. Many wires are available also in white and black giving the suspended track solutions the perfect finish for your customer.



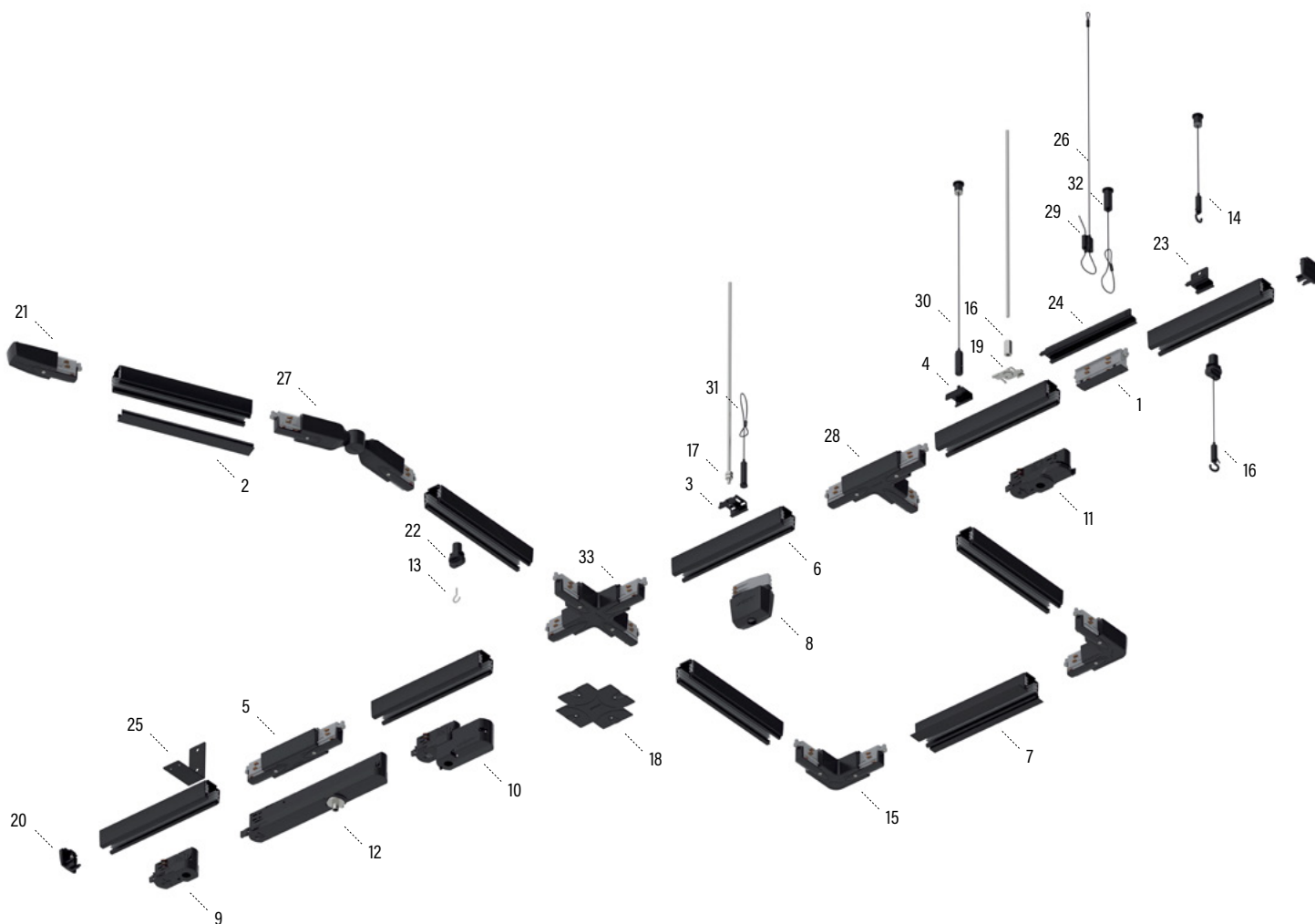

NO.	TYPE	ITEM	PAGE
1	Joining unit	UNIPRO JU3	8
2	Cover strip	UNIPRO CS3B	8
3	Ceiling bracket	UNIPRO CB3B	23
4	Quick ceiling bracket	UNIPRO QCB B	23
5	Middle connection unit	UNIPRO MCU3B	9
6	3-phase lighting track	UNIPRO T32B	6
7	3-phase lighting track, recessed	UNIPRO T32FB	7
8	Power outlet adapter	UNIPRO A100B	20
9	Luminaire adapter	UNIPRO A75B	18
10	Bluetooth control unit	UNIPRO A80BT B	20
11	Luminaire adapter	UNIPRO A90B	18
12	In-Track Driver adapter	UNIPRO A203B	19
13	Suspension hook	UNIPRO SH	27
14	Adjustable wire suspension set with hook	UNIPRO WS40H	22
15	L-corner	UNIPRO LC3B	9
16	Extension nut for threaded rod M6	JM M6 EG	27

NO.	TYPE	ITEM	PAGE
17	Nut for threaded rod M6	MU M6 EG	27
18	Cover plate	UNIPRO CP3B	8
19	Quick connector	UNIPRO QC3G	23
20	End cap	UNIPRO EC3B	8
21	Connection unit	UNIPRO CU3AB	9
22	Suspension clamp	UNIPRO SC3B	24
23	Pendant bracket	UNIPRO PB B	23
24	Pendant coupler	UNIPRO PC B	24
25	Wall bracket	UNIPRO WB B	24
26	Ø1,5 mm wire with loop	UNIPRO WL40 B	26
27	Adjustable corner	UNIPRO ALC3B	10
28	T-piece	UNIPRO TA3AB	10
29	Adjustable wire gripper	UNIPRO WG B	26
30	Adjustable wire suspension set	UNIPRO WS40 B	25
31	Adjustable wire set with loop wire	UNIPRO WS40L B	25
32	Adjustable wire set with loop wire	UNIPRO WSL40 B	25
33	X-piece	UNIPRO XA3B	10

LIGHTING TRACK FOR SURFACE INSTALLATION

16 A | 250/400 VAC | 50 Hz | CLASS I IP20

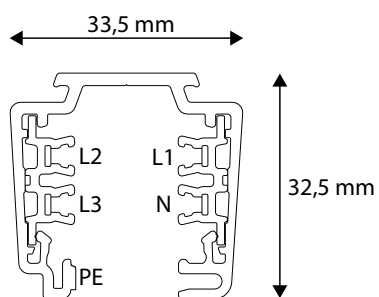
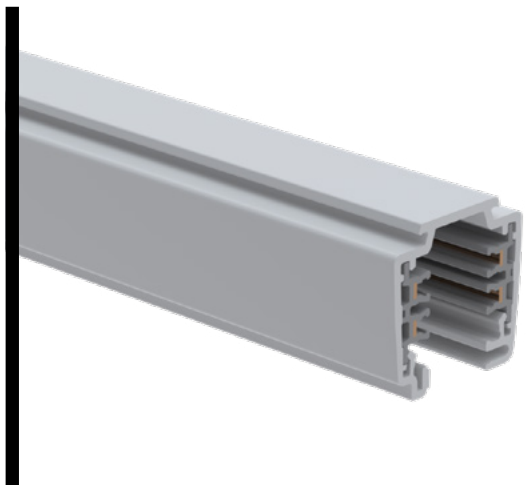

CODE	PRODUCT x = stock product	WGT. kg / pce	LENGTH mm	COLOUR	PACKAGE
1459160	x UNIPRO T312W	0.94	1200	White	10 PCE / 12 MTR
1459102	x UNIPRO T32W	1.567	2000	White	10 PCE / 20 MTR
1459292	x UNIPRO T324W	1.88	2400	White	10 PCE / 24 MTR
1459103	x UNIPRO T33W	2.348	3000	White	5 PCE / 15 MTR
1459304	x UNIPRO T34W	3.134	4000	White	5 PCE / 20 MTR
1459166	UNIPRO T312G	0.94	1200	Grey	10 PCE / 12 MTR
1459232	UNIPRO T32G	1.567	2000	Grey	10 PCE / 20 MTR
1459293	UNIPRO T324G	1.88	2400	Grey	10 PCE / 24 MTR
1459233	UNIPRO T33G	2.348	3000	Grey	5 PCE / 15 MTR
1459304	UNIPRO T34G	3.134	4000	Grey	5 PCE / 20 MTR
1459159	x UNIPRO T312B	0.94	1200	Black	10 PCE / 12 MTR
1459302	x UNIPRO T32B	1.567	2000	Black	10 PCE / 20 MTR
1459180	x UNIPRO T324B	1.88	2400	Black	10 PCE / 24 MTR
1459303	x UNIPRO T33B	2.348	3000	Black	5 PCE / 15 MTR
1459304	x UNIPRO T34B	3.134	4000	Black	5 PCE / 20 MTR

RECESSED LIGHTING TRACK

16 A | 250/400 VAC | 50 Hz | CLASS 1 IP20

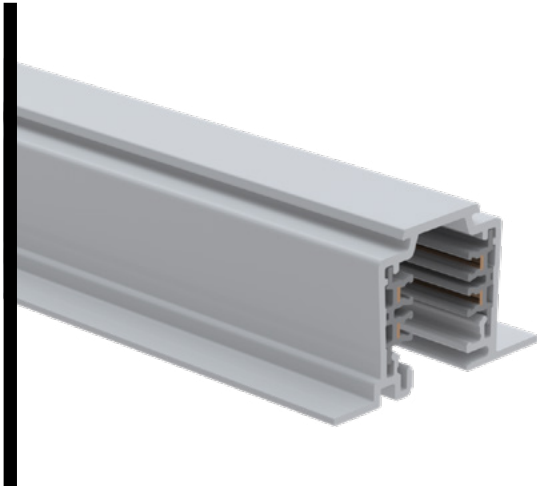

CODE	PRODUCT x = stock product	WGT. kg / pce	LENGTH mm	COLOUR	PACKAGE
1459112	UNIPRO T32FW	1.785	2000	White	90 PCE / 180 MTR
1459114	UNIPRO T34FW	3.569	4000	White	90 PCE / 360 MTR
1459182	UNIPRO T32FG	1.785	2000	Grey	90 PCE / 180 MTR
1459184	UNIPRO T34FG	3.569	4000	Grey	90 PCE / 360 MTR
1459312	UNIPRO T32FB	1.785	2000	Black	90 PCE / 180 MTR
1459314	UNIPRO T34FB	3.569	4000	Black	90 PCE / 360 MTR

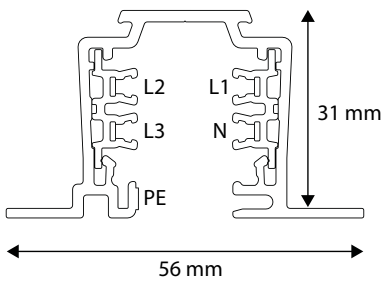

unipro® T3 lighting tracks

Materials	The lighting track frame is made of aluminium and the insulation is made of plastic. The phase and neutral wires are made of 2.5mm ² rectangular copper, protective earthing is achieved with the lighting track's aluminium frame. Surface treatment options are painted white (RAL9003), grey (RAL7040), black (RAL9005) and anodised natural colour. Other RAL Classic paint colours.
Wires	Three phase wires (L1, L2 and L3), neutral wire (N) and protective earthing (PE).
Protection class	Protection class 1 IP20
Quality and safety	Tested in compliance with EN60570 and EN60598.
Other	Can be cut to the appropriate length on site. Copper wires do not need to be bent or otherwise worked on after cutting.

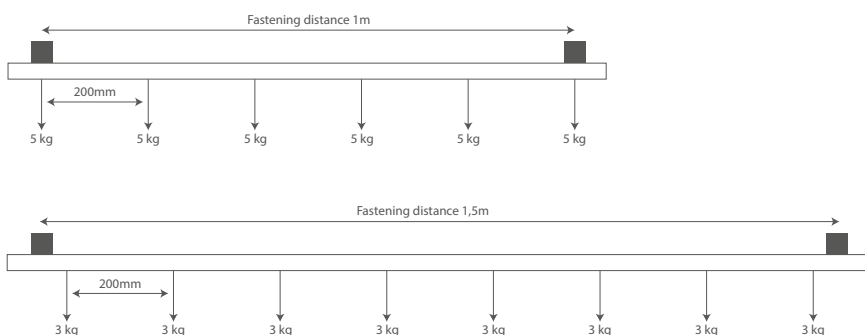

END CAP EC3

End cap for 3-phase lighting tracks.



ENR	PRODUCT x = stock product	WGT. kg / pce	COLOUR	PACKAGE
1459181	x UNIPRO EC3W	0.006	White	20 PCE / 1 BG
1459281	x UNIPRO EC3G	0.006	Grey	20 PCE / 1 BG
1459381	x UNIPRO EC3B	0.006	Black	20 PCE / 1 BG

COVER STRIP L=2M CS3

Cover strip for 3-phase and Control-DALI lighting tracks. Length 2m.

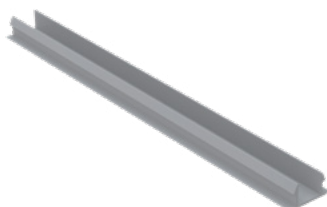

ENR	PRODUCT x = stock product	WGT. kg / pce	COLOUR	PACKAGE
1459444	x UNIPRO CS3W	0.125	White	8 PCE / 16 MTR
1459445	x UNIPRO CS3B	0.125	Black	8 PCE / 16 MTR

COVER PLATE CP3

Cover plate for recessed lighting track systems, to cover the CU and MCU connection units as well as the L-, T- and X-pieces. Can be folded to the suitable shape during installation.



ENR	PRODUCT x = stock product	WGT. kg / pce	COLOUR	PACKAGE
1459191	x UNIPRO CP3W	0.017	White	20 PCE / 1 BG
1459291	x UNIPRO CP3G	0.017	Grey	20 PCE / 1 BG
1459391	x UNIPRO CP3B	0.017	Black	20 PCE / 1 BG

JOINTING UNIT JU3

Jointing unit for 3-phase lighting tracks. Product comes with grey and black covers. A cover can be installed by pressing it on top of the jointing unit.



ENR	PRODUCT x = stock product	WGT. kg / pce	PACKAGE
1459199	x UNIPRO JU3	0.043	10 PCE / BG

CONNECTION UNIT CU3

Power supply option for 3-phase lighting track systems. Two earthing options. Screw terminals for 3x1.5mm² - 5x2.5mm² wires.

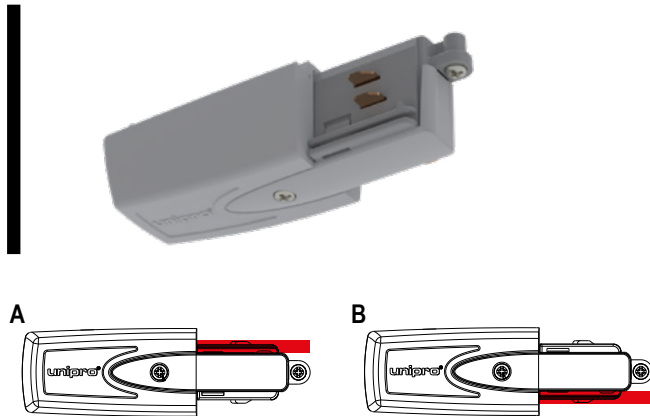

Please note! Earthing pictures taken from below.

ENR	PRODUCT x = stock product	WGT. kg / pce	COLOUR	PACKAGE
1459121	x UNIPRO CU3AW	0.058	White	10 PCE / 1 BG
1459221	x UNIPRO CU3AG	0.058	Grey	10 PCE / 1 BG
1459321	x UNIPRO CU3AB	0.058	Black	10 PCE / BG

1459122	x UNIPRO CU3BW	0.058	White	10 PCE / 1 BG
1459222	x UNIPRO CU3BG	0.058	Grey	10 PCE / 1 BG
1459322	x UNIPRO CU3BB	0.058	Black	10 PCE / 1 BG

MIDDLE CONNECTION UNIT MCU3

Power supply option for 3-phase lighting track systems. Screw terminals for 3x1.5mm² - 5x2.5mm² wires.



ENR	PRODUCT x = stock product	WGT. kg / pce	COLOUR	PACKAGE
1459131	x UNIPRO MCU3W	0.104	White	8 PCE / 1 BG
1459231	x UNIPRO MCU3G	0.104	Grey	8 PCE / 1 BG
1459331	x UNIPRO MCU3B	0.104	Black	8 PCE / 1 BG

L-CORNER LC3

Power supply option for 3-phase lighting track systems. Changeable earthing line position. Screw terminals for 3x1.5mm² - 5x2.5mm² wires.

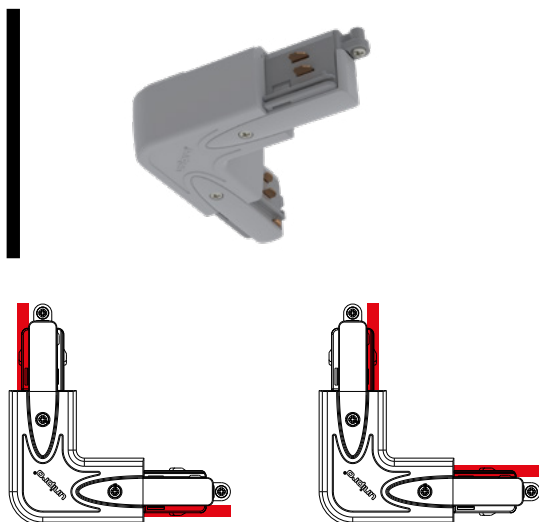

Please note! Earthing pictures taken from below.

ENR	PRODUCT x = stock product	WGT. kg / pce	COLOUR	PACKAGE
1459141	x UNIPRO LC3W	0.105	White	6 PCE / 1 BG
1459241	x UNIPRO LC3G	0.105	Grey	6 PCE / 1 BG
1459341	x UNIPRO LC3B	0.105	Black	6 PCE / 1 BG

ADJUSTABLE CORNER ALC3

Horizontal adjustment range $0 \pm 120^\circ$.

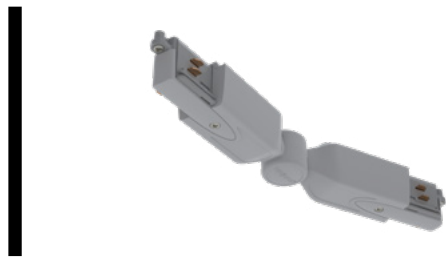

ENR	PRODUCT x = stock product	WGT. kg / pce	COLOUR	PACKAGE
1459151	x UNIPRO ALC3W	0.13	White	4 PCE / 1 BG
1459251	x UNIPRO ALC3G	0.13	Grey	4 PCE / 1 BG
1459351	x UNIPRO ALC3B	0.13	Black	4 PCE / 1 BG

T-PIECE TA3

Power supply option for 3-phase lighting track systems. Four earthing options.
Screw terminals for $3 \times 1.5\text{mm}^2 - 5 \times 2.5\text{mm}^2$ wires.

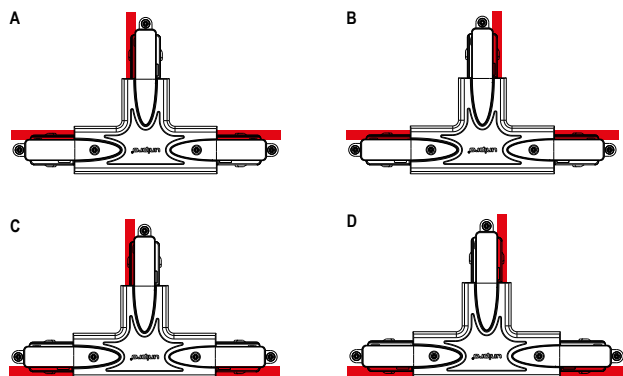
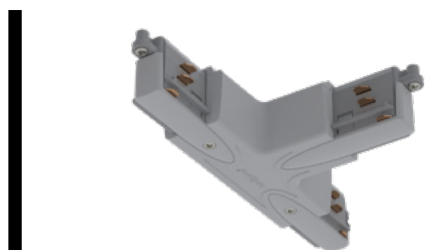

Please note! Earthing pictures taken from below.

ENR	PRODUCT x = stock product	WGT. kg / pce	COLOUR	PACKAGE
1459161	x UNIPRO TA3AW	0.15	White	4 PCE / 1 BG
1459261	x UNIPRO TA3AG	0.15	Grey	4 PCE / 1 BG
1459361	x UNIPRO TA3AB	0.15	Black	4 PCE / 1 BG

1459162	x UNIPRO TA3BW	0.15	White	4 PCE / 1 BG
1459262	x UNIPRO TA3BG	0.15	Grey	4 PCE / 1 BG
1459362	x UNIPRO TA3BB	0.15	Black	4 PCE / 1 BG

1459163	x UNIPRO TA3CW	0.15	White	4 PCE / 1 BG
1459263	x UNIPRO TA3CG	0.15	Grey	4 PCE / 1 BG
1459363	x UNIPRO TA3CB	0.15	Black	4 PCE / 1 BG

1459164	x UNIPRO TA3DW	0.15	White	4 PCE / 1 BG
1459264	x UNIPRO TA3DG	0.15	Grey	4 PCE / 1 BG
1459364	x UNIPRO TA3DB	0.15	Black	4 PCE / 1 BG

X-PIECE XA3

Power supply option for 3-phase lighting track systems. Screw terminals for $3 \times 1.5\text{mm}^2 - 5 \times 2.5\text{mm}^2$ wires.

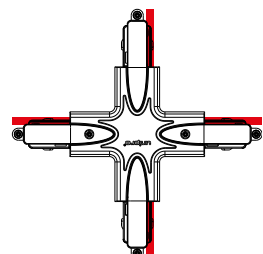
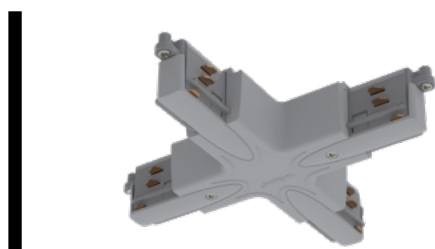

Please note! Earthing pictures taken from below.

ENR	PRODUCT x = stock product	WGT. kg / pce	COLOUR	PACKAGE
1459171	x UNIPRO XA3W	0.196	White	2 PCE / 1 BG
1459271	x UNIPRO XA3G	0.196	Grey	2 PCE / 1 BG
1459371	x UNIPRO XA3B	0.196	Black	2 PCE / 1 BG

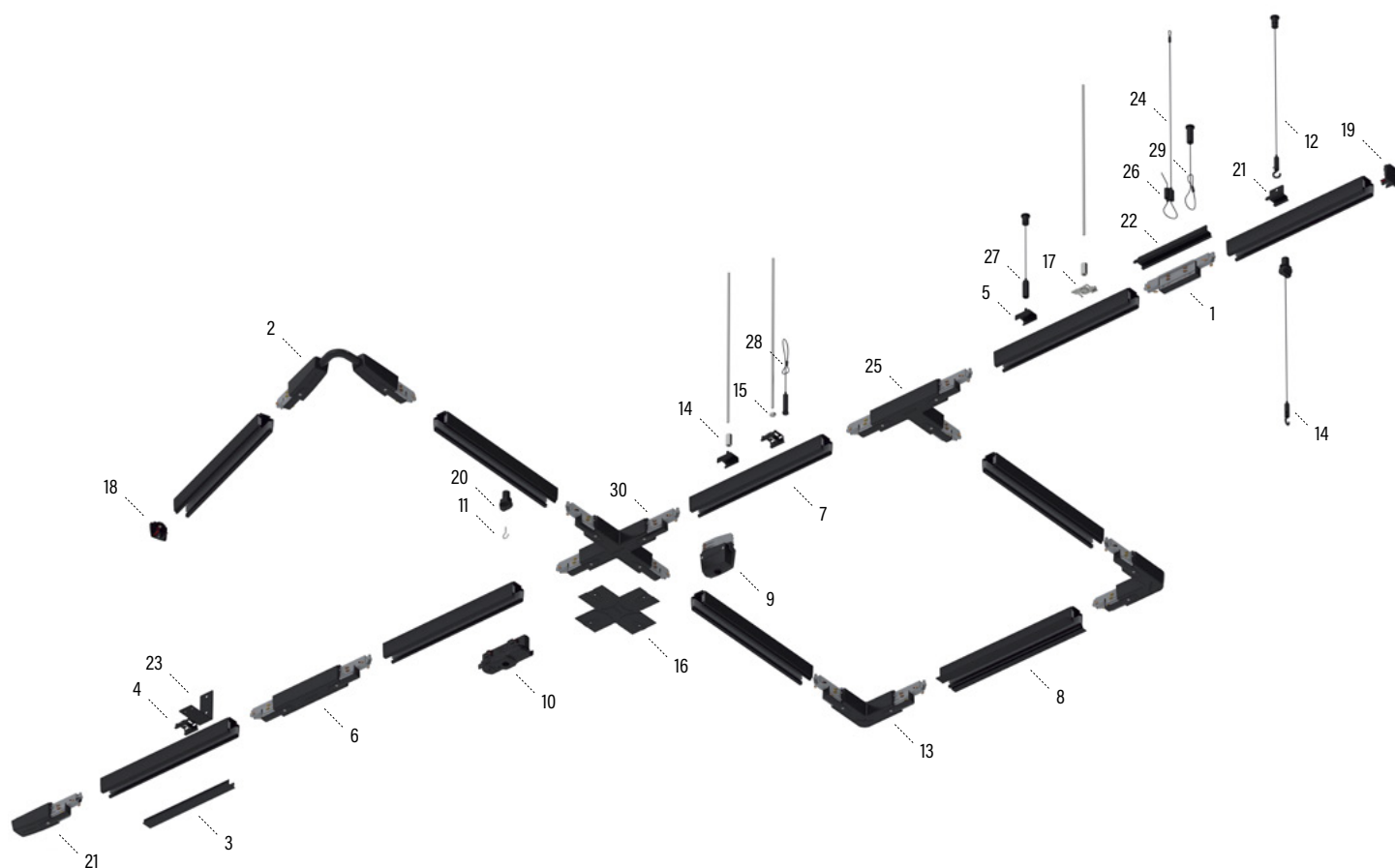

NO.	TYPE	ITEM	PAGE
1	Control-DALI Jointing unit	UNIPRO CJU3	15
2	Control-DALI Adjustable corner	UNIPRO CFC3 B	15
3	Cover strip L=2m	UNIPRO CS3B	14
4	Ceiling bracket	UNIPRO CB3B	23
5	Quick ceiling bracket	UNIPRO QCB B	23
6	Control-DALI Middle connection unit	UNIPRO CMCU3B	15
7	Control-DALI lighting track	UNIPRO TC32B	12
8	Control-DALI lighting track, recessed	UNIPRO TC32FB	13
9	Power outlet adapter	UNIPRO A100B	20
10	Control-DALI Luminaire adapter	UNIPRO A90CB	18
11	Suspension hook	UNIPRO SH	27
12	Adjustable wire suspension set with hook	UNIPRO WS40H	25
13	Control-DALI L-corner	UNIPRO CLC3B	16
14	Extension nut for threaded rod M6	JM M6 EG	27
15	Nut for threaded rod M6	MU M6 EG	27

NO.	TYPE	ITEM	PAGE
16	Control-DALI Cover plate	UNIPRO CCP3 B	14
17	Quick connector	UNIPRO QC3G	23
18	Control-DALI End cap	UNIPRO CEC3B	14
19	Control-DALI Connection unit	UNIPRO CCU3AB	15
20	Suspension clamp	UNIPRO SC3B	24
21	Pendant bracket	UNIPRO PB B	23
22	Pendant coupler	UNIPRO PC B	24
23	Wall bracket	UNIPRO WB B	24
24	Ø1,5 mm wire with loop	UNIPRO WL40 B	26
25	Control-DALI T-piece	UNIPRO CTA3AB	16
26	Adjustable wire gripper	UNIPRO WG B	26
27	Adjustable wire suspension set	UNIPRO WS40 B	25
28	Adjustable wire set with loop wire	UNIPRO WS40L B	25
29	Adjustable wire set with loop wire	UNIPRO WSL40 B	25
30	Control-DALI X-piece	UNIPRO CXA3B	17

CONTROL-DALI LIGHTING TRACK FOR SURFACE INSTALLATION

Control-DALI lighting track for surface installation.

16 A, (250/400) VAC, 50 Hz, FELV ≤ 50VAC ≤ 1A, CLASS 1 IP20.

Free of halogens and PVCs.

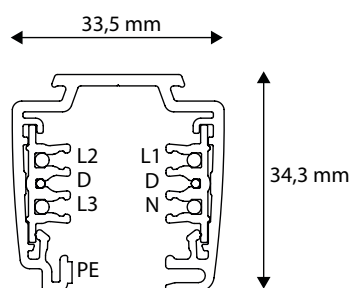
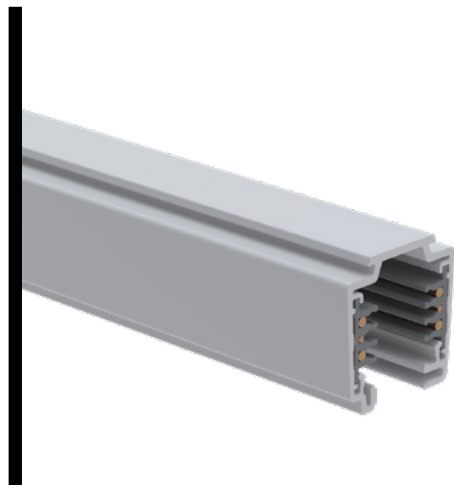

CODE	PRODUCT x = stock product	WGT. kg / pce	LENGTH mm	COLOUR	PACKAGE
1459243	x UNIPRO TC312W	1.075	1200	White	10 PCE / 12 MTR
1459107	x UNIPRO TC32W	1.792	2000	White	10 PCE / 20 MTR
1459253	x UNIPRO TC324W	2.15	2400	White	10 PCE / 24 MTR
1459108	x UNIPRO TC33W	2.763	3000	White	5 PCE / 15 MTR
1459109	x UNIPRO TC34W	3.684	4000	White	5 PCE / 20 MTR
1459294	UNIPRO TC312G	1.075	1200	Grey	10 PCE / 24 MTR
1459237	UNIPRO TC32G	1.792	2000	Grey	10 PCE / 20 MTR
1459254	UNIPRO TC324G	2.15	2400	Grey	10 PCE / 24 MTR
1459238	UNIPRO TC33G	2.763	3000	Grey	5 PCE / 15 MTR
1459239	UNIPRO TC34G	3.684	4000	Grey	5 PCE / 20 MTR
1459242	x UNIPRO TC312B	1.075	1200	Black	10 PCE / 12 MTR
1459307	x UNIPRO TC32B	1.792	2000	Black	10 PCE / 20 MTR
1459250	x UNIPRO TC324B	2.15	2400	Black	10 PCE / 24 MTR
1459308	x UNIPRO TC33B	2.763	3000	Black	5 PCE / 15 MTR
1459309	x UNIPRO TC34B	3.684	4000	Black	5 PCE / 20 MTR

RECESSED UNIPRO CONTROL-DALI LIGHTING TRACK

Recessed Control-DALI lighting track.
 16 A, (250/400) VAC, 50Hz, FELV ≤ 50VAC ≤ 1A, CLASS 1 IP20.

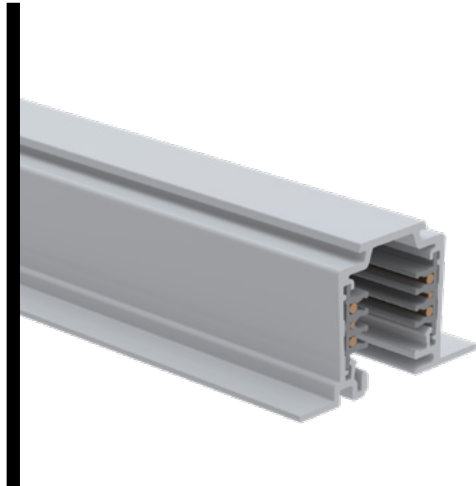

CODE	PRODUCT x = stock product	WGT. kg / pce	LENGTH mm	COLOUR	PACKAGE
1459117	UNIPRO TC32FW	2.064	2000	White	8 PCE / 19.2 MTR
1459119	UNIPRO TC34FW	4.228	4000	White	8 PCE / 38.4 MTR
1459187	UNIPRO TC32FG	2.064	2000	Grey	8 PCE / 19.2 MTR
1459189	UNIPRO TC34FG	4.228	4000	Grey	8 PCE / 38.4 MTR
1459317	UNIPRO TC32FB	2.064	2000	Black	8 PCE / 19.2 MTR
1459319	UNIPRO TC34FB	4.228	4000	Black	8 PCE / 38.4 MTR

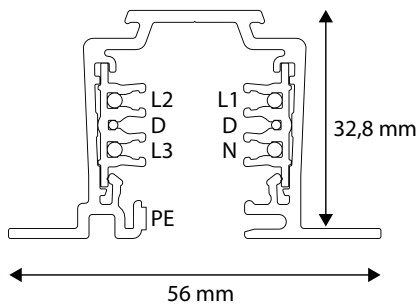

unipro® Control-DALI TC3 lighting tracks

Control-DALI

Materials	The lighting track frame is made of aluminium and the insulation is made of halogen and PVC-free plastic. The phase and neutral wires are made of 4mm ² round copper, control wires are made of 1.5mm ² round copper. Protective earthing is achieved with the lighting track's aluminium frame. Surface treatment options are painted white (RAL9003), grey (RAL7040), black (RAL9005) and anodised natural colour. Other RAL Classic paint colours are possible with custom orders.
Wires	Three phase wires (L1, L2 and L3), neutral wire (N), protective earthing (PE) and data wires (D).
Protection class	Protection class 1 IP20
Quality and safety	Tested in compliance with EN60570 and EN60598.
Other	Can be cut to the appropriate length on site. Phase wires must be shortened by 5mm with TCCP copper cutting pliers.

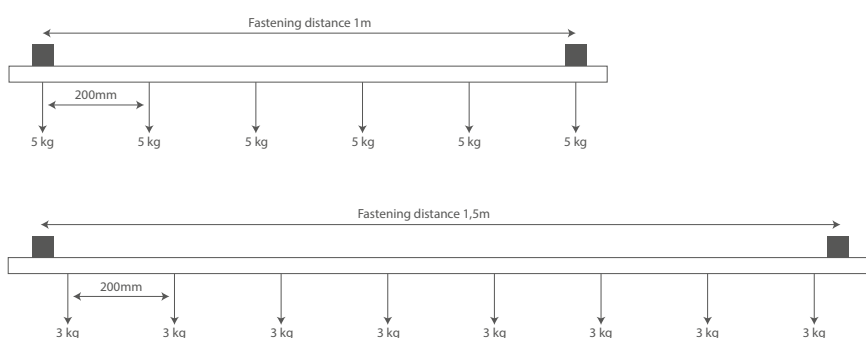

COPPER CUTTING PLIERS FOR CONTROL-DALI TRACKS TCCP

Control-DALI lighting tracks' L1, L2, L3 and N wires need to be shortened 5mm after cutting the lighting track so that the required electrical and safety clearances and distances are fulfilled.



CODE	PRODUCT x = stock product	WGT. kg / pce	LENGTH mm	PACKAGE
1459190	x UNIPRO TCCP	0.2	250	1 PCE

CONTROL-DALI END CAP CEC3

End cap for Control-DALI lighting tracks.



CODE	PRODUCT x = stock product	WGT. kg / pce	COLOUR	PACKAGE
1459196	x UNIPRO CEC3W	0.006	White	20 PCE / 1 BG
1459285	x UNIPRO CEC3G	0.006	Grey	20 PCE / 1 BG
1459385	x UNIPRO CEC3B	0.006	Black	20 PCE / 1 BG

COVER STRIP L=2M CS3

Cover strip for 3-phase and Control-DALI lighting tracks. Length 2m.

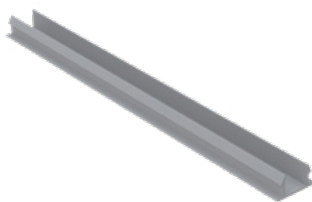

CODE	PRODUCT x = stock product	WGT. kg / pce	COLOUR	PACKAGE
1459444	x UNIPRO CS3W	0.125	White	8 PCE / 16 MTR
1459445	x UNIPRO CS3B	0.125	Black	8 PCE / 16 MTR

CONTROL-DALI COVER PLATE CCP3

Cover plate for recessed Control-DALI lighting track systems, to cover the CCU and CMCU connection units as well as the L-, T- and X-pieces. Can be folded to the suitable shape during installation.



CODE	PRODUCT x = stock product	WGT. kg / pce	COLOUR	PACKAGE
1459101	x UNIPRO CCP3 W	0.028	White	20 PCE / 1 BG
1459111	x UNIPRO CCP3 B	0.028	Black	20 PCE / 1 BG
1459120	x UNIPRO CCP3 G	0.028	Grey	20 PCE / 1 BG

CONTROL-DALI JOINTING UNIT CJU3

Jointing unit for Control-DALI lighting track systems. Product comes with grey and black covers. A cover can be installed by pressing it on top of the jointing unit.

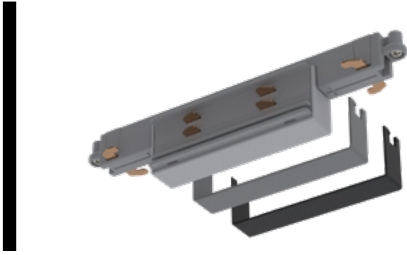

CODE	PRODUCT x = stock product	WGT. kg / pce	PACKAGE
1459198	x UNIPRO CJU3	0.053	8 PCE / 1 BG

CONTROL-DALI CONNECTION UNIT CCU3

Power supply option for Control-DALI track systems. Two earthing options. Screw terminals for 1.5mm² - 2.5mm² wires.



CODE	PRODUCT x = stock product	WGT. kg / pce	COLOUR	PACKAGE
1459125	x UNIPRO CCU3AW	0.079	White	8 PCE / 1 BG
1459225	x UNIPRO CCU3AG	0.079	Grey	8 PCE / 1 BG
1459325	x UNIPRO CCU3AB	0.079	Black	8 PCE / 1 BG

1459126	x UNIPRO CCU3BW	0.079	White	8 PCE / 1 BG
1459226	x UNIPRO CCU3BG	0.079	Grey	8 PCE / 1 BG
1459326	x UNIPRO CCU3BB	0.079	Black	8 PCE / 1 BG

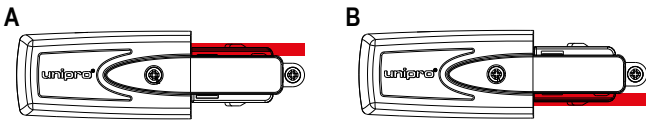

Please note! Earthing pictures taken from below.

CONTROL-DALI MIDDLE CONNECTION UNIT CMCU3

Power supply option for Control-DALI track systems. Screw terminals for 1.5mm² - 2.5mm² wires.

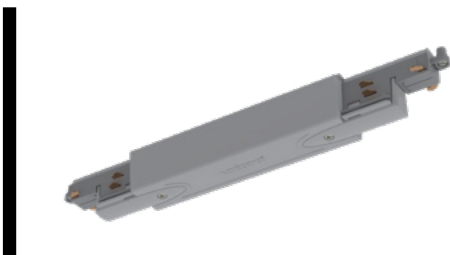

CODE	PRODUCT x = stock product	WGT. kg / pce	COLOUR	PACKAGE
1459129	x UNIPRO CMCU3W	0.159	White	5 PCE / 1 BG
1459228	x UNIPRO CMCU3G	0.159	Grey	5 PCE / 1 BG
1459335	x UNIPRO CMCU3B	0.159	Black	5 PCE / 1 BG

CONTROL-DALI ADJUSTABLE CORNER CFC

Power supply option for Control-DALI track systems. Screw terminals for 1.5mm² - 2.5mm² wires.



CODE	PRODUCT x = stock product	WGT. kg / pce	COLOUR	PACKAGE
1459154	x UNIPRO CFC3 W	0.2	White	1 PCE
1459152	x UNIPRO CFC3 B	0.2	Black	1 PCE

CONTROL-DALI L-CORNER CLC3

Power supply option for Control-DALI track systems. Changeable earthing line position.
Screw terminals for 1.5mm² - 2.5mm² wires.



CODE	PRODUCT x = stock product	WGT. kg / pce	COLOUR	PACKAGE
1459153	x UNIPRO CLC3W	0.158	White	4 PCE / 1 BG
1459245	x UNIPRO CLC3G	0.158	Grey	4 PCE / 1 BG
1459345	x UNIPRO CLC3B	0.158	Black	4 PCE / 1 BG

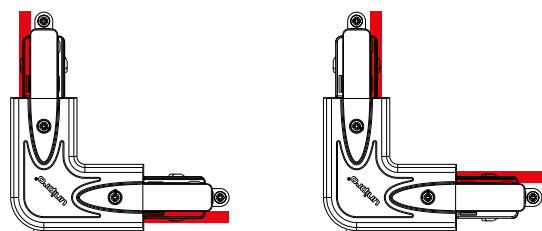

Please note! Earthing pictures taken from below.

CONTROL-DALI T-PIECE CTA3

Power supply option for Control-DALI track systems. Four earthing options.
Screw terminals for 1.5mm² - 2.5mm² wires.



CODE	PRODUCT x = stock product	WGT. kg / pce	COLOUR	PACKAGE
1459155	x UNIPRO CTA3AW	0.24	White	2 PCE / 1 BG
1459255	x UNIPRO CTA3AG	0.24	Grey	2 PCE / 1 BG
1459355	x UNIPRO CTA3AB	0.24	Black	2 PCE / 1 BG
1459156	x UNIPRO CTA3BW	0.24	White	2 PCE / 1 BG
1459256	x UNIPRO CTA3BG	0.24	Grey	2 PCE / 1 BG
1459356	x UNIPRO CTA3BB	0.24	Black	2 PCE / 1 BG
1459157	x UNIPRO CTA3CW	0.24	White	2 PCE / 1 BG
1459257	x UNIPRO CTA3CG	0.24	Grey	2 PCE / 1 BG
1459357	x UNIPRO CTA3CB	0.24	Black	2 PCE / 1 BG
1459158	x UNIPRO CTA3DW	0.24	White	2 PCE / 1 BG
1459258	x UNIPRO CTA3DG	0.24	Grey	2 PCE / 1 BG
1459358	x UNIPRO CTA3DB	0.24	Black	2 PCE / 1 BG

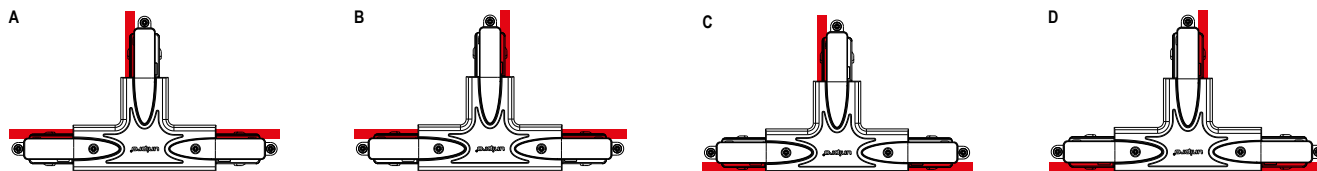

Please note! Earthing pictures taken from below.

CONTROL-DALI X-PIECE CXA3

Power supply option for Control-DALI track systems. Screw terminals for 1.5mm² - 2.5mm² wires.

unipro®

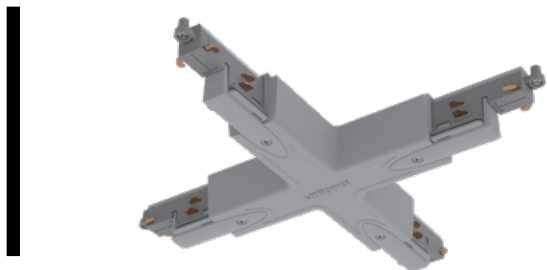

CODE	PRODUCT x = stock product	WGT. kg / pce	COLOUR	PACKAGE
1459167	x UNIPRO CXA3W	0.323	White	1 PCE / 1 BG
1459275	x UNIPRO CXA3G	0.323	Grey	1 PCE / 1 BG
1459375	x UNIPRO CXA3B	0.323	Black	1 PCE / 1 BG

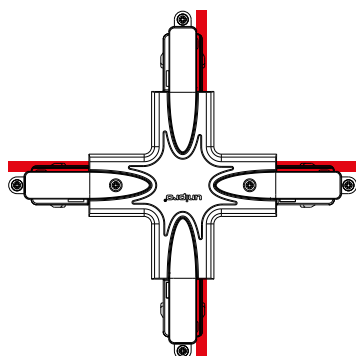

Please note! Earthing picture taken from below.



LUMINAIRE ADAPTER A75

Rated values for 3-phase lighting track system: 6A, 250V | Pull strength 5kg, with L70 locking lever 7kg.



CODE	PRODUCT x = stock product	WGT. kg / pce	COLOUR	PACKAGE
1459014	x UNIPRO A75W	0.034	White	12 PCE / 1 BG
1459016	x UNIPRO A75G	0.034	Grey	12 PCE / 1 BG
1459015	x UNIPRO A75B	0.034	Black	12 PCE / 1 BG

LUMINAIRE ADAPTER A90

Rated values for 3-phase lighting track system: 6A, 250V | Pull strength 10kg.

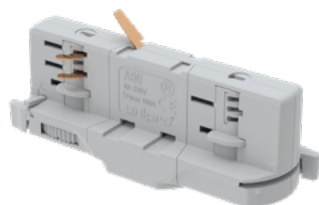

CODE	PRODUCT x = stock product	WGT. kg / pce	COLOUR	PACKAGE
1459029	x UNIPRO A90W	0.047	White	8 PCE / 1 BG
1459031	x UNIPRO A90G	0.047	Grey	8 PCE / 1 BG
1459030	x UNIPRO A90B	0.047	Black	8 PCE / 1 BG

CONTROL-DALI LUMINAIRE ADAPTER A90C

Rated values for Control-DALI system: 6A, 250V | FELV ≤50VAC ≤1A | Pull strength 10kg.

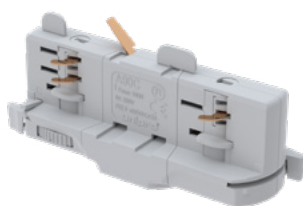

CODE	PRODUCT x = stock product	WGT. kg / pce	COLOUR	PACKAGE
1459026	x UNIPRO A90CW	0.047	White	8 PCE / 1 BG
1459028	x UNIPRO A90CG	0.047	Grey	8 PCE / 1 BG
1459027	x UNIPRO A90CB	0.047	Black	8 PCE / 1 BG

IN-TRACK DRIVER ADAPTER A201

29-42 W, length 270 mm, for 3-phase lighting track systems

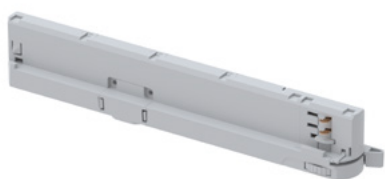

CODE	PRODUCT x = stock product	WGT. kg / pce	COLOUR	PACKAGE
1459374	UNIPRO A201W	0.07	White	1 PCE
1459376	UNIPRO A201B	0.07	Black	1 PCE
1459373	UNIPRO A201G	0.07	Grey	1 PCE

IN-TRACK DRIVER ADAPTER A204CA

42 W, length 270 mm, for 3-phase lighting track systems including Casambi

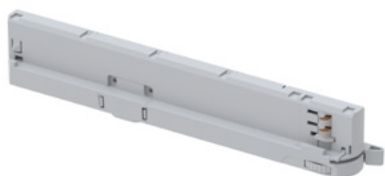

CODE	PRODUCT x = stock product	WGT. kg / pce	COLOUR	PACKAGE
1459298	UNIPRO A204CAW	0.07	White	1 PCE
1459299	UNIPRO A204CAB	0.07	Black	1 PCE
1459300	UNIPRO A204CAG	0.07	Grey	1 PCE

CONTROL-DALI IN-TRACK DRIVER ADAPTER A204C

42 W, length 270 mm, for 3-phase lighting track systems



CODE	PRODUCT x = stock product	WGT. kg / pce	COLOUR	PACKAGE
1459295	UNIPRO A204CW	0.07	White	1 PCE
1459296	UNIPRO A204CB	0.07	Black	1 PCE
1459297	UNIPRO A204CG	0.07	Grey	1 PCE

POWER OUTLET ADAPTER A100

Power supply with 1-or 3-phase power, only compatible with unipro® 3-phase and Control-DALI lighting tracks. Cannot be used on DALI control.



CODE	PRODUCT x = stock product	WGT. kg / pce	COLOUR	PACKAGE
1459011	x UNIPRO A100W	0.065	White	6 PCE / 1 BG
1459013	x UNIPRO A100G	0.065	Grey	6 PCE / 1 BG
1459012	x UNIPRO A100B	0.065	Black	6 PCE / 1 BG

MONOPOINT FOR ADAPTER A75 MP

Rated values: 10A, 250V | Pull strength 5kg.

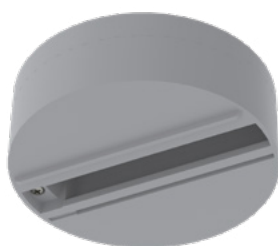

CODE	PRODUCT x = stock product	WGT. kg / pce	COLOUR	PACKAGE
1459040	x UNIPRO MP W	0.1	White	1 PCE
1459042	x UNIPRO MP G	0.1	Grey	1 PCE
1459041	x UNIPRO MP B	0.1	Black	1 PCE

INSTALLATION TOOL T1L

Tool for attaching wires to lighting adapters A75, A90 and A90C.



CODE	PRODUCT x = stock product	WGT. kg / pce	COLOUR	PACKAGE
1459099	x UNIPRO T1L	0.1	Grey	1 PCE

AL-NIPPLE M10 ALN

Lighting fixture for lighting adapter, M10 thread. Available thread lengths: 8mm and 12mm.



CODE	PRODUCT x = stock product	WGT. kg / pce	COLOUR	PACKAGE
1459091	x UNIPRO ALN10R8	0.005	Grey	100 PCE / 1 BG
1459092	x UNIPRO ALN10R12	0.006	Grey	100 PCE / 1 BG

COUNTER NUT FOR AL-NIPPLE NM10

M10 locknut for ALN10.



CODE	PRODUCT x = stock product	WGT. kg / pce	COLOUR	PACKAGE
1459428	x UNIPRO NM10	0.01	Grey	100 PCE / 1 BG

CABLE CLAMP CC70

Strain relief for lighting adapter.



CODE	PRODUCT x = stock product	WGT. kg / pce	COLOUR	PACKAGE
1459010	x UNIPRO CC70	0.002	Grey	100 PCE / 1 BG

QUICK CEILING BRACKET QCB

Tool-less snap installation to lighting tracks. Can be used with wire suspension set WS or threaded rod GT-6 with extension nut. Pull strength 15kg.



CODE	PRODUCT x = stock product	WGT. kg / pce	COLOUR	PACKAGE
1459421	x UNIPRO QCB W	0.008	White	10 PCE / 1 BG
1459422	x UNIPRO QCB G	0.008	Grey	10 PCE / 1 BG
1459423	x UNIPRO QCB B	0.008	Black	10 PCE / 1 BG

QUICK CONNECTOR QC3

Twist to fasten to lighting track. M6 screw on top, grey, can be used with wire suspension sets, and threaded rods with extension nut. Pull strength 8kg.



CODE	PRODUCT x = stock product	WGT. kg / pce	COLOUR	PACKAGE
1459100	x UNIPRO QC3G	0.008	Grey	10 PCE / 1 BG

CEILING BRACKET CB3

Steel ceiling clamp. Can be attached to wire suspension sets and threaded rods. Pull strength 20kg.



CODE	PRODUCT x = stock product	WGT. kg / pce	COLOUR	PACKAGE
1459401	x UNIPRO CB3W	0.014	White	10 PCE / 1 BG
1459402	x UNIPRO CB3G	0.014	Grey	10 PCE / 1 BG
1459403	x UNIPRO CB3B	0.014	Black	10 PCE / 1 BG

CEILING BRACKET FOR T-BAR CB3 T-BAR

Steel 24mm T-bar clamp. Pull strength 5kg.



CODE	PRODUCT x = stock product	WGT. kg / pce	COLOUR	PACKAGE
1459451	x UNIPRO CB3W T-BAR	0.022	White	10 PCE / 1 BG
1459452	x UNIPRO CB3G T-BAR	0.022	Grey	10 PCE / 1 BG
1459453	x UNIPRO CB3B T-BAR	0.022	Black	10 PCE / 1 BG

PENDANT BRACKET PB

Steel pendant bracket. Used with hooked wire suspension set WS40H, or wire set WSL40. Pull strength 20kg.



CODE	PRODUCT x = stock product	WGT. kg / pce	COLOUR	PACKAGE
1459407	x UNIPRO PB W	0.02	White	10 PCE / 1 BG
1459408	x UNIPRO PB G	0.02	Grey	10 PCE / 1 BG
1459409	x UNIPRO PB B	0.02	Black	10 PCE / 1 BG

PENDANT COUPLER PC

Steel pendant bracket. Used on lighting track joints with hooked wire suspension set WS40H or WSL40.
Pull strength 20kg.



CODE	PRODUCT x = stock product	WGT. kg / pce	COLOUR	PACKAGE
1459431	x UNIPRO PC W	0.085	White	10 PCE / 1 BG
1459432	x UNIPRO PC G	0.085	Grey	10 PCE / 1 BG
1459433	x UNIPRO PC B	0.085	Black	10 PCE / 1 BG

WALL BRACKET WB

Steel wall bracket. Used with ceiling bracket CB3. Pull strength 3kg.



CODE	PRODUCT x = stock product	WGT. kg / pce	COLOUR	PACKAGE
1459436	x UNIPRO WB W	0.045	White	10 PCE / 1 BG
1459437	x UNIPRO WB B	0.045	Black	10 PCE / 1 BG

SUSPENSION CLAMP SC3

Pull strength 10kg, for 3-phase and Control-DALI lighting tracks.



CODE	PRODUCT x = stock product	WGT. kg / pce	COLOUR	PACKAGE
1459440	x UNIPRO SC3W	0.065	White	10 PCE / 1 BG
1459441	x UNIPRO SC3G	0.065	Grey	10 PCE / 1 BG
1459442	x UNIPRO SC3B	0.065	Black	10 PCE / 1 BG

ADJUSTABLE WIRE SUSPENSION SET WS

Wire suspension set for CB3, QC3 and QCB brackets. Pull strength 15kg, WS40 W pull strength 12kg.



CODE	PRODUCT x = stock product	WGT. kg / pce	LENGTH mm	COLOUR	PACKAGE
1459410	x UNIPRO WS15	0.054	1500	Grey	1 PCE / 1 BG
1459415	x UNIPRO WS15 B	0.05	1500	Black	1 PCE / 1 BG
1459411	x UNIPRO WS40	0.08	4000	Grey	1 PCE / 1 BG
1459416	x UNIPRO WS40 B	0.08	4000	Black	1 PCE / 1 BG
1459417	x UNIPRO WS40 W	0.08	4000	White	1 PCE / 1 BG
1459412	x UNIPRO WS60	0.11	6000	Grey	1 PCE / 1 BG

ADJUSTABLE WIRE SUSPENSION SET WITH HOOK WS40H

Wire suspension set for PB and PC brackets, pull strength 10kg.

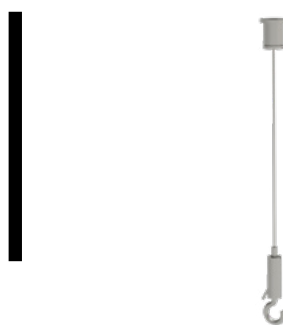

CODE	PRODUCT x = stock product	WGT. kg / pce	LENGTH mm	COLOUR	PACKAGE
1459414	x UNIPRO WS40H	0.08	4000	Grey	1 PCE / 1 BG

ADJUSTABLE WIRE SET WITH LOOP WIRE WS40L

Wire suspension set for CB3, QC3 and QCB brackets, pull strength 15kg.



CODE	PRODUCT x = stock product	WGT. kg / pce	LENGTH mm	COLOUR	PACKAGE
1459128	x UNIPRO WS40L	0.05	4000	Grey	1 PCE / 1 BG
1459130	x UNIPRO WS40L B	0.05	4000	Black	1 PCE / 1 BG

WIRE SET WITH ADJUSTABLE CEILING ATTACHMENT AND LOOP WIRE WSL40

Wire suspension set for PB and PC brackets, pull strength 15kg.

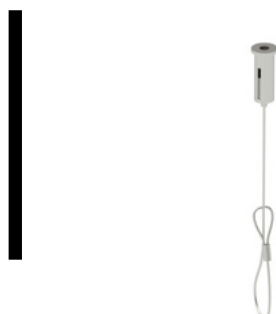

CODE	PRODUCT x = stock product	WGT. kg / pce	LENGTH mm	COLOUR	PACKAGE
1459135	x UNIPRO WSL40	0.05	4000	Grey	1 PCE / 1 BG
1459136	x UNIPRO WSL40 B	0.05	4000	Black	1 PCE / 1 BG

Ø1.5 MM WIRE WITH LOOP WL40

Ø1.5mm wire with loop, pull strength 15 kg, to be used with e.g. a WG wire gripper.



CODE	PRODUCT x = stock product	WGT. kg / pce	LENGTH mm	COLOUR	PACKAGE
1459146	x UNIPRO WL40	0.05	4000	Grey	1 PCE / 1 BG
1459150	x UNIPRO WL40 B	0.05	4000	Black	1 PCE / 1 BG

ADJUSTABLE WIRE GRIPPER WG

Cable lock for Ø1.5mm wires, pull strength 20kg.



CODE	PRODUCT x = stock product	WGT. kg / pce	COLOUR	PACKAGE
1459140	x UNIPRO WG	0.01	Grey	50 PCE
1459145	x UNIPRO WG B	0.01	Black	50 PCE

WIRE REEL, Ø=1.5MM, L=50M WR

50 metre Ø1.5 mm cable spool, steel grey, pull strength 15 kg, to be used with e.g. a WG wire gripper.

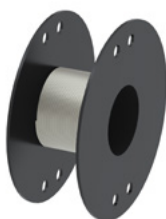

CODE	PRODUCT x = stock product	WGT. kg / pce	LENGTH mm	COLOUR	PACKAGE
1459127	x UNIPRO WR	0.8	50000	Grey	1 PCE / 1 BG

SUSPENSION HOOK SH

Pull strength 1kg, for SC3 suspension base.



CODE	PRODUCT x = stock product	WGT. kg / pce	COLOUR	PACKAGE
1459443	x UNIPRO SH	0.002	Grey	100 PCE / 1 BG

NUT MU / EXTENSION NUT JM

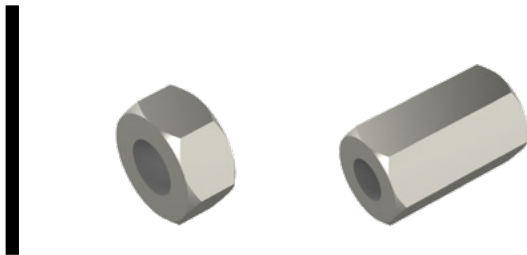

CODE	PRODUCT x = stock product	WGT. kg / pce	COLOUR	PACKAGE
1459427	MU M6 EG	0.01	Grey	100 PCE / 1 BG

CODE	PRODUCT x = stock product	WGT. kg / pce	COLOUR	PACKAGE
1459425	JM M6 EG	0.01	Grey	100 PCE / 1 BG



Helvar

Intelligence of ActiveAhead® Combined With the Benefits of DALI Addressing

Helvar's ActiveAhead® is now available with UNIPRO 3-phase DALI track system.

ActiveAhead® now connects to DALI devices and the benefits of this can now be brought into Unipro DALI lighting track solution.

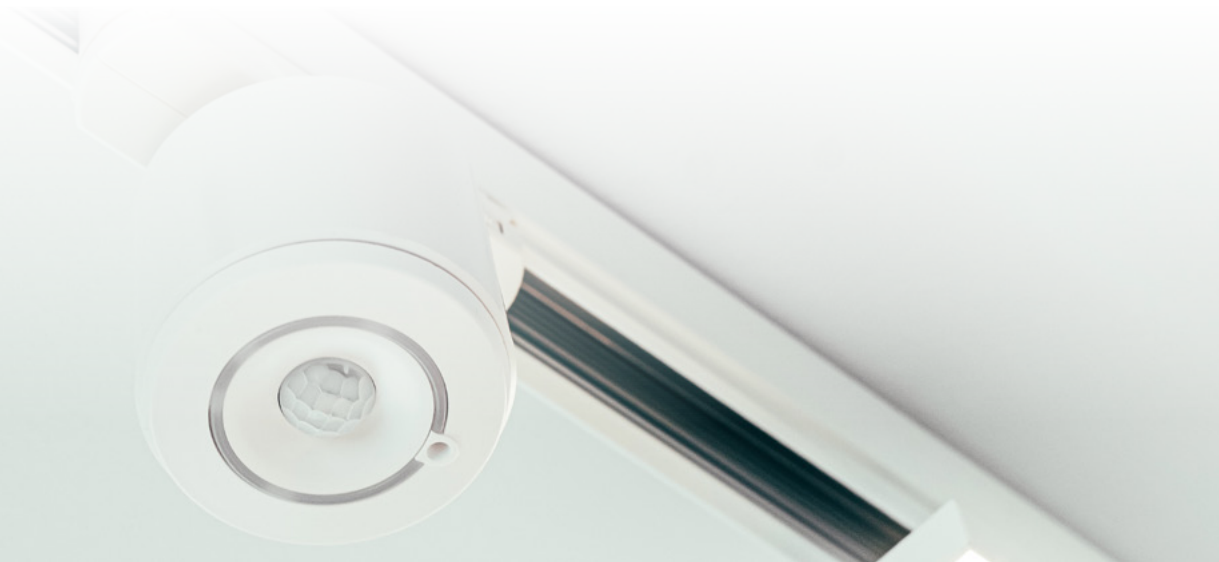

5609

ActiveAhead® Node Advanced for DALI



CODE	PRODUCT	PACKAGE
	x = stock product	

113165	HELVAR 5609	1 PCE
--------	-------------	-------

320TR & 320BTR

PIR Sensor + A90C, white for DALI

PIR Sensor + A90C, black for DALI



CODE	PRODUCT	PACKAGE
	x = stock product	

113166	HELVAR 320TR	1 PCE
113167	HELVAR 320BTR	1 PCE

321TR & 321BTR

MULTISensor + A90C, white for DALI

MULTISensor + A90C, black for DALI



CODE	PRODUCT	PACKAGE
	x = stock product	

113168	HELVAR 321TR	1 PCE
113169	HELVAR 321BTR	1 PCE

322TR & 322BTR

High Bay MULTISensor + A90C, white for DALI

High Bay MULTISensor + A90C, black for DALI



CODE	PRODUCT	PACKAGE
	x = stock product	

113170	HELVAR 322TR	1 PCE
113171	HELVAR 322BTR	1 PCE

320D2TR & 320BD2TR

PIR Sensor (DALI-2) + A90C, white
PIR Sensor (DALI-2) + A90C, black



CODE	PRODUCT	PACKAGE
	x = stock product	
113172	HELVAR 320D2TR	1 PCE
113173	HELVAR 320BD2TR	1 PCE

321D2TR & 321BD2TR

MULTISensor (DALI-2) + A90C, white for DALI
MULTISensor (DALI-2) + A90C, black for DALI



CODE	PRODUCT	PACKAGE
	x = stock product	
113174	HELVAR 321D2TR	1 PCE
113175	HELVAR 321BD2TR	1 PCE

322D2TR & 322DTRB

High Bay MULTISensor (DALI-2) + A90C, white for DALI
High Bay MULTISensor (DALI-2) + A90C, black for DALI



CODE	PRODUCT	PACKAGE
	x = stock product	
113176	HELVAR 322D2TR	1 PCE
113177	HELVAR 322DTRB	1 PCE



making
your
lights
shne

UNIPRO OY LTD

ITÄPORTINTIE 1, 13430 HÄMEENLINNA, FINLAND
+358 207 450 800
WWW.UNIPRO.FI